



**PASSION, EXPERIENCE,
COMMITMENT AND INNOVATION**



TWISTER S5 + S6



mañeozano
N-TWISTER

DANGER
NO RECKLESS
MANUEVERING

STANDARD EQUIPMENT

- Cold rolled structural tube frame
- Telescopic drawbar
- Side step for reaching tank filler lid
- Jockey wheel support
- High quality polyethylene main tank with uniform thickness and front and side level indicator.
- Hand-washing and circuit-washing tank
- Multiple filtering system
- Product Mixer
- Cleaning robot inside the main tank
- Hydraulic Agitator
- High pressure piston pump with reducer shaft
- Electric ON/OFF controls
- Internal transmission category 4 SAE G7
- External transmission and connection to CV tractor category 4 SAE G7



Pump specially designed for sprayers. This pump is mounted with a reducer and a through shaft : the through shaft allows us to directly transmit the revolutions of the tractor joint shaft to the air system, and the reducer decreases the revolutions of the pump crankshaft, lowering the power absorption and, therefore, both the fuel consumption and wear of the pump.



Control with double switch to increase or decrease pressure (optional) and two switches to activate or deactivate the left and right solenoid valves.

FEATURES



01



02



03

- 01 Removable side wings to allow easy access to the inside of the machine for lubrication, oil changes, etc.
- 02 Easy opening of the twister assembly for storage.
- 03 Redesigned, quieter adjustable curved blades deliver increased throughput while consuming less power.

TWISTER



- 01 JOCKEY WHEEL
- 02 PUMP WITH THROUGH GEARBOX SHAFT
- 03 ELECTRIC CONTROL
- 04 FRONT LEVEL INDICATOR
- 05 POLYETHYLENE HAND-WASHING TANK
- 06 POLYETHYLENE CIRCUIT- WASHING TANK
- 07 POLYETHYLENE MAIN TANK
- 08 TWISTER TURBINE
- 09 FOLDING OPENING SYSTEM
- 10 DURALUMIN ROTOR CORE
- 11 ALUMINIUM CLUTCH LININGS
- 12 ADJUSTABLE BLADES WITH CURVED DESIGN
- 13 TRIPLE ADJUSTABLE NOZZLE
- 14 STEP
- 15 TWO SPEED AND NEUTRAL GEARBOX TRANSMISSION
- 16 WHEELS 10. 0/ 75 -1 5 . 3"
- 17 HYDRAULIC STIRRER
- 18 STRUCTURAL TUBE AND FOLDED SHEET FRAME

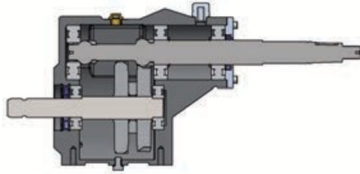

TWISTER GEARBOX

- Parallel axles with two speeds and neutral
- Built with a cast iron housing for exceptional strength and durability, ensuring long-lasting performance even under demanding working conditions.
- Transmission ratio for slow speed 1: 3.5 and 1: 4.4 for fast speed
- The gear system is lubricated in an oil bath
- Easy access and maintenance
- Mechanism able to support strong power

TRONIC CONTROL SYSTEM

- Automatic flow control (DPA): Adjusts litres per minute based on tractor speed and row spacing.
- 3.2" TFT color display (320x240): View all functions simultaneously for easy operation.
- On-screen alarms: Instantly identify electrical faults and system issues.
- Work agenda: Store up to 50 orchards and 15 treatment programs for efficient management.

SISTROMATIC CONTROL SYSTEM

- Ultrasonic sensors for precise tree detection
- Real-time plant and tree counter for accurate monitoring
- Input/output delay control to optimise spray timing
- 3.2" TFT color screen (320x240) with backlit keyboard
- On-screen alarms for quick electrical fault detection

OPTIONAL EQUIPMENT



DRAWBAR TO TRACTOR COUPLING



DRAWBAR TO THE TRACTOR ARMS



ANTI-LEAF FLAP



REAR DRAWER



HYDRAULIC BRAKES



WHEELS 3 4 0/5 5 -16"



LIGHT INSTALLATION



ELECTRICAL VALVE PRESSURE REGULATION KIT



TRONIC VOLUMETRIC CONTROL KIT



SISTROMATIC CONTROL KIT WITHOUT FLOWMETER



ANTI-LEAF GRATE

TWISTER AIR SYSTEM

- Polyethylene fan housing Stainless Steel deflector with 18 blades to ensure even distribution on both sides of the air volume
- Three-channel air duct system which increases production, preventing rapid air produced at the top of the rotor colliding with the slow air generated in the central part
- Two-speed and neutral gearbox transmission
- Rotor with aluminium core and steel jacket to prevent wear due to friction with the clutch
- Eight adjustable blades with curved design that reduces power absorption and lowers the noise level and fuel consumption.
- Aluminium clutch linings which enable smooth and progressive start up
- Stainless steel supply pipes
- Triple anti-drip nozzle holders with spray tip nozzles
- Twister spiral system which generates spray at the air flow outlet, allowing us to maintain the vegetation of the moving plant, preventing the shielding effect that prevents the air flow and liquid flow from entering the inside of the tree. The system prevents the excess concentrated liquid at the same point from draining and spilling onto the ground and polluting the environment.



Twister S5 model has 5 diffusers per side and is specially designed for deciduous plantations



The Twister S6 model has a pipeline system which allows you to incorporate 6 nozzles per side for working on plantations with tall trees

THE POWER OF THE TWISTER AIR SYSTEM

THE TWISTER AIR SYSTEM TAKES INSPIRATION FROM THE NATURAL FORCE OF A VORTEX — POWERFUL, CONTROLLED, AND PERFECTLY CIRCULAR. ENGINEERED TO REPLICATE THIS SPIRALLING MOTION, ITS AIRFLOW IS DESIGNED TO WRAP AROUND THE ENTIRE PLANT, REACHING DEEP INTO EVEN THE DENSEST CANOPIES.

BY SURROUNDING EACH TREE WITH A UNIFORM, HIGH-VELOCITY AIR STREAM, THE SYSTEM ENSURES COMPLETE SPRAY PENETRATION ON EVERY LEAF, BRANCH, AND FRUIT SURFACE. THE RESULT IS A 100% EFFECTIVE, CONSISTENT TREATMENT THAT MAXIMISES COVERAGE, MINIMISES WASTE, AND DELIVERS PERFORMANCE BEYOND CONVENTIONAL AIR SYSTEMS.

THE TWISTER NOZZLE HOLDER SYSTEM

IN TANDEM WITH THIS TECHNOLOGICAL BREAKTHROUGH, WE DEVELOPED A NEW NOZZLE HOLDER DESIGN THAT ALLOWS THE USE OF THREE NOZZLES SIMULTANEOUSLY, WITH A TOTAL OF 30 TO 36 NOZZLES PER UNIT.

EACH HOLDER DIRECTS THE NOZZLES AT STRATEGICALLY DIFFERENT ANGLES, DELIVERING A 145° SPRAY COVERAGE — A SIGNIFICANT ADVANTAGE OVER THE 45° RANGE OF CONVENTIONAL SYSTEMS.

WHEN COMBINED WITH THE TWISTER AIR SYSTEM, THIS INNOVATIVE CONFIGURATION CREATES A PRECISE, HIGH-PERFORMANCE SPRAY PATTERN THAT ENSURES UNIFORM TREATMENT INSIDE AND OUTSIDE THE TREE CANOPY, ACHIEVING CONSISTENT, PROFESSIONAL RESULTS ACROSS EVERY ORCHARD.

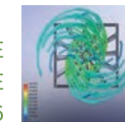

TECHNICAL SPECIFICATIONS / FAN SPECIFICATIONS

NARROW SERIES

NARROW TW S4 - S5	Tank capacity (Litres)			Shaft-Rim-Tire		
	Main	Hand wash Tank	Cleaning tank	Shaft	Connection	Tire
1000 PE	1000	15	100	45x1100	94 - 5T	10.0/80/12"
1500 PE	1500	15	150	50x1250 50x1200	161 - 6T	10.0/75/15.3"
2000 PE	2000	15	200	50x1300 50x1350	161 - 6T	10.0/75/15.3"
3000 PE	3000	15	300	70x1500	161 - 6T	11.5/80/15.3"
TW S4 Inox.	TW S5 Inox.	TW S5 Invertido DTWS/5INV		TW S5 PE		

Narrow TW S6	Tank capacity (Litres)			Shaft-Rim-Tire		
	Main	Hand wash Tank	Cleaning tank	Shaft	Connection	Tire
1500 PE	1500	15	150	50x1250 50x1200	161 - 6T	10.0/75/15.3"
2000 PE	2000	15	200	50x1300 50x1350	161 - 6T	10.0/75/15.3"
3000 PE	3000	15	300	70x1500	161 - 6T	400/60/15.5"

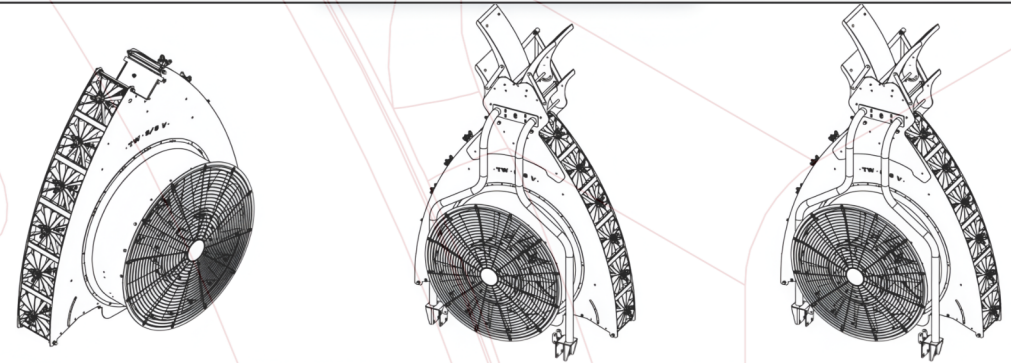
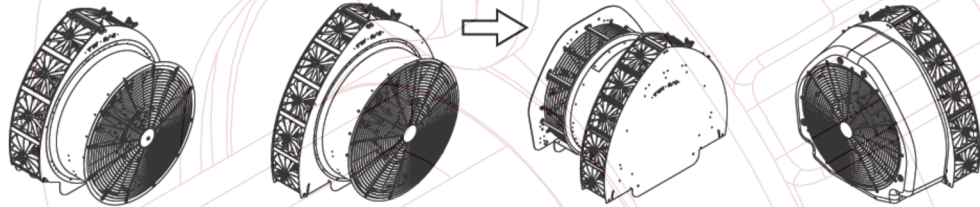



Fan (Ø cm)	Blades	Gears	Nozzles	Clutch	480 RPM
820	8	1	24	✓	27
		2			38
920	8	1	30	✓	40
		2			51



TW S6		TW S6 + Top manual		TW S6 + Top hydraulic	
Fan (Ø cm)	Blades	Gears	Nozzles	Clutch	480 RPM
920	8	1	36+2	✓	40
		2			51
920 (TOP)	8	1	36+8	✓	40
		2			51







TECHNICAL SPECIFICATIONS / FAN SPECIFICATIONS

MEGA SERIES

MEGA TW S5	 Tank capacity (Litres)			 Shaft-Rim-Tire		
	Main	Hand wash Tank	Cleaning tank	Shaft	Connection	Tire
2000 (Fibra)	2000	15	200	60 x 1700	161 - 6T	11.5 / 80 - 15.3"
2500 (Fibra)	2500	15	250	60 x 1700	161 - 6T	11.5 / 80 - 15.3"
3000 (Fibra)	3000	15	300	70 x 1700	161 - 6T	400/ 60 - 11.5"
4000 (Fibra)	4000	15	400	70 x 1700	161 - 6T	500 / 50 - 17"

 Fan (Ø cm)	 Blades	 Gears	 Nozzles	 Clutch	 540 RPM
920	8	<hr/> 1 2	30	✓	<hr/> 40 51

MEGA TW S6	 Tank capacity (Litres)			 Shaft-Rim-Tire		
	Main	Hand wash Tank	Cleaning tank	Shaft	Connection	Tire
2000 (Fibra)	2000	15	200	60 x 1700	161 - 6T	11.5 / 80 - 15.3"
2500 (Fibra)	2500	15	250	60 x 1700	161 - 6T	11.5 / 80 - 15.3"
3000 (Fibra)	3000	15	300	70 x 1700	161 - 6T	400/ 60 - 11.5"
4000 (Fibra)	4000	15	400	70 x 1700	161 - 6T	500 / 50 - 17"

 Fan (Ø cm)	 Blades	 Gears	 Nozzles	 Clutch	 540 RPM
920	8	<hr/> 1 2	36	✓	<hr/> 40 51
920 (TOP)	8	<hr/> 1 2	36 + 8	✓	<hr/> 40 51

TECHNICAL SPECIFICATIONS / FAN SPECIFICATIONS SUPER SERIES

SUPER TW S5 CA	Tank capacity (Litres)			Shaft-Rim-Tire		
	Main	Hand wash Tank	Cleaning tank	Shaft	Connection	Tire
2000 (Fibra)	2000	15	200	60 x 1800	161 - 6T	11.5 / 80 - 15.3"
2500 (Fibra)	2500	15	250	60 x 1800	161 - 6T	13.0 / 65 - 18"
3000 (Fibra)	3000	15	300	70 x 1900	161 - 6T	400 / 60 - 15.5"
4000 (Fibra)	4000	15	400	70 x 1900	161 - 6T	500 / 50 - 17"

Fan (Ø cm)	Blades	Gears	Nozzles	Clutch	480 RPM
920	8	1 2	30 + 2	✓	40 51

SUPER TW S6	Tank capacity (Litres)			Shaft-Rim-Tire		
	Main	Hand wash Tank	Cleaning tank	Shaft	Connection	Tire
2000 (Fibra)	2000	15	200	60 x 1800	161 - 6T	11.5 / 80 - 15.3"
2500 (Fibra)	2500	15	250	60 x 1800	161 - 6T	13.0 / 65 - 18"
3000 (Fibra)	3000	15	300	70 x 1900	161 - 6T	400 / 60 - 15.5"
4000 (Fibra)	4000	15	400	70 x 1900	161 - 6T	500 / 50 - 17"

Fan (Ø cm)	Blades	Gears	Nozzles	Clutch	540 RPM/920
920	8	1 2	18	✓	40 51
920 (TOP)	8	1 2	36 + 8	✓	40 51

CONTACT US



✉ info@twisteragmachinery.com.au

✉ accounts@twisteragmachinery.com.au

☎ 0475 904 798 / 0405 149 016

🌐 www.twisteragmachinery.com